

# Commercial, Civilian, and Military Communications

Worldwide Communication Routes and Links are at Risk

Version Four

Very Low  
Frequencies  
can be Easily  
Jammed

Submarines  
Can Cut  
Cables

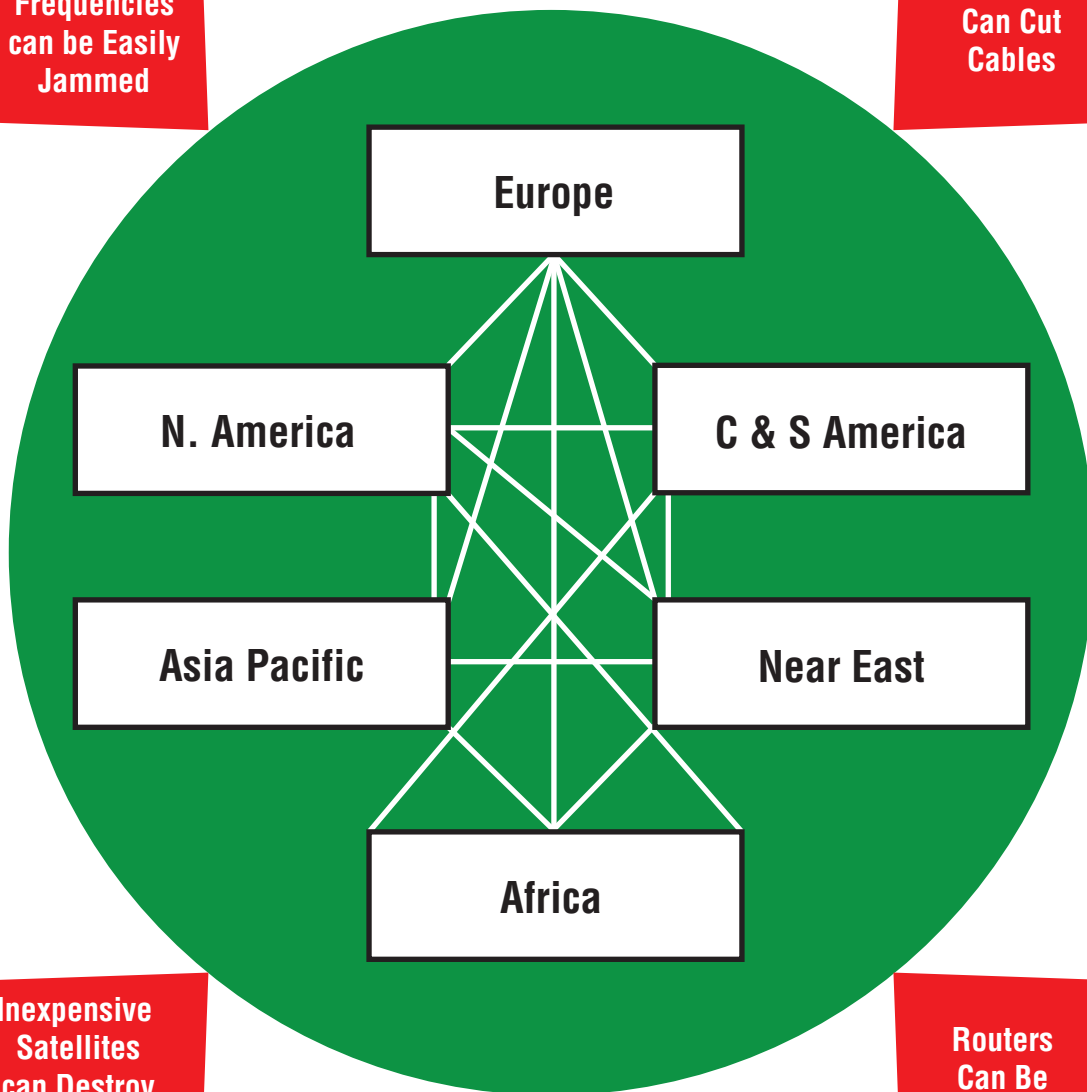

Inexpensive  
Satellites  
can Destroy  
Expensive  
Useful Satellites

Routers  
Can Be  
Selective

Solution  
Inside

## **CHALLENGE:**

Russia and China could easily destroy USA worldwide communication. This would cripple our military and NATO military abilities, and perhaps cause a world wide business depression in “Western Civilization”.

The world is changing faster than many citizens in Western Civilization can understand.

- 1) China and Russia appear to be drifting closer together
- 2) Russian actions in Ukraine, not only serious for Ukraine, but for US military future
- 3) It is well known that “Western Civilization” is supplying Ukraine with detailed satellite maps
- 4) Compare physical dimensions of Russia and China (thousands of miles) to the LEO heights
- 5) Soon, both countries will claim they own the space above their countries!
- 6) China and Russia can then shoot down any satellite
- 7) China and Russia can hack any satellite.
- 8) Russia can cut undersea cables in Atlantic Ocean between USA, Europe, and Africa
- 9) Hua Wei now owns most of the Internet Routers in the eastern world

Today, Russia and China can destroy our worldwide communication with a much lower cost than it will cost to keep it working or replace it. China is moving very fast in satellite communications, AI, and in associated theory

## **SOME SUGGESTION SOLUTIONS:**

- 1) Hide extra satellites for each network, and then drop them down as needed
- 2) Install mini-nuclear reactors in each satellite so that the network has power to quickly move

Hidden satellites can be discovered, and destroyed in advance, or can be quickly later destroyed  
Nuclear reactors are expensive, and cost is measured in billions, and solution will take years  
The problem is TODAY, not some time in the future.

## **CONCLUSION:**

Our tiny research company, StarMesh has low cost bullet proof satellite communication technology. In a few months, our technology could be operational in space.

Our technology REVERSES the cost to destroy problem. It will cost China and Russia much more to destroy our system, than it costs to keep replacing satellites in the StarMesh system.

## **STAR MESH ISSUES:**

Our technology is complicated and involves distributed intelligence and new algorithms. Although when understood it is easy to build and code, however, it is very difficult to understand. Most satellite experts would say this will never work. There is nothing else like it!  
In business we are like tiny ants running around underneath the hoofs of elephants.

## **STAR MESH ANSWER**

We have published patents on how this works. We also are working on future patent applications to increase the capacity of our system. This could be built and launched in a time table measured in months, not years. (Many chip sets are available)

## Overview of today's technology

### GEOSTATIONARY SATELLITES

Geostationary satellites are placed into altitudes about 22,000 miles. At this high altitude they orbit once each 24 hours. Thus, when placed over the Equator, they appear as stationary to an observer on earth. This permits careful design of matching antennas, and can provide communication.

The problems with this approach are several.

- 1) To get good communication, they launch with pre-folded large antennas that unfold in space.
- 2) The earth side of the communication link needs good antennas.
- 3) Cost is very high
- 4) Everybody knows their location, and thus they are easy to find and shoot down.  
Yes, several companies in the world have operational systems.

The Russians have invented a modification to this, perhaps operational also by a British company where the satellites move sequentially north and south of the Equator, and thus temporarily end up over higher latitudes. With several satellites in each position that permits any earth location to be continuously covered. This is accomplished by tilting the orbit planes.

### LEOS

Low Earth Orbit Satellites are normally in orbits from about 300 miles to about 500 or more miles. These speed around the earth and complete an orbit in about 90 minutes. They can supply good signal strength. To make connections to earth, the challenge is large. To make connections between themselves, they are typically placed into some sort of grid, so that antennas can be lined up, and routes can be defined as two hops south and three hops east.

The problems with this approach are several.

- 1) They must be held precisely horizontal (rockets and rocket fuel)
- 2) They must be maintained in precise orbits to maintain the grid (rockets and fuel)
- 3) Thus they are expensive, and expensive to replace
- 4) Everybody knows their location, and thus they are easy to find and shoot down.  
Yes, several companies in the world have operational systems. Iridium uses polar orbits, and when they reach typical latitudes, they form a grid.

### STARMESH TECHNOLOGY

Just remove all rockets, rocket fuel, and let them wander and tumble in a free form manner. The cost is almost nothing but a simple router, and perhaps 18 radio chip sets. The antennas can point in all directions, and the solar panels can be free form. This requires more satellites for satisfactory statistical operation. Later inventions permit an approximate horizontal stability which lowers costs. This requires NEW INVENTIVE COMPLEX COMPARISONS AND NEW INVENTIVE MEASUREMENTS.



US010084536B1

(12) **United States Patent**  
Schloemer

(10) **Patent No.:** US 10,084,536 B1  
(45) **Date of Patent:** Sep. 25, 2018

(54) RADIO SYSTEM USING SATELLITES

4,965,850 A 10/1990 Schloemer  
5,274,840 A 12/1993 Schwendeman



US010447381B2

(12) **United States Patent**  
Schloemer

(10) **Patent No.:** US 10,447,381 B2  
(45) **Date of Patent:** \*Oct. 15, 2019

(54) RADIO SYSTEM USING NODES

(58) **Field of Classification Search**  
CPC ..... H04B 7/18513; H04B 7/18515; H04B



US010085200B1

(12) **United States Patent**  
Schloemer

(10) **Patent No.:** US 10,085,200 B1  
(45) **Date of Patent:** \*Sep. 25, 2018

(54) RADIO SYSTEM USING NODES WITH HIGH GAIN ANTENNAS

(56) **References Cited**  
U.S. PATENT DOCUMENTS



US010291316B1

(12) **United States Patent**  
Schloemer

(10) **Patent No.:** US 10,291,316 B1  
(45) **Date of Patent:** May 14, 2019

(54) DATA TRANSMISSION SYSTEMS AND METHODS USING SATELLITE-TO-SATELLITE RADIO LINKS

(56) **References Cited**  
U.S. PATENT DOCUMENTS



US010979136B2

(12) **United States Patent**  
Schloemer

(10) **Patent No.:** US 10,979,136 B2  
(45) **Date of Patent:** Apr. 13, 2021

(54) COMMUNICATIONS SYSTEMS AND METHODS WITH STOCHASTICALLY DISTRIBUTED ORBITING SATELLITES

(58) **Field of Classification Search**  
CPC ..... H04B 7/185; H04B 7/18515; H04B 7/18517; H04B 7/18521; H04B 7/18532;

## ***PATENT DISCUSSION:***

To attempt to truly understand our technology, these patents should be read in sequence. This will take serious time, as hundreds and hundreds of pages are involved.

The final patent, 10,979,136, was issued in April 2021. We filed our first provisional for this on July 12, 2018. Thus this shows our thinking as of about early winter 2018. That was over 4 years ago. Since that time, we have filed additional US and PCT applications, and are working on one more. We have further ones waiting in line. These new applications and their associated research are directed to increasing capacity and lowering already low cost.

## **HOW AND WHY IT WORKS:**

Iridium proved that about 64 satellites in polar orbits could cover the earth. However, in reality, this system was very inefficient near the poles in order to work at typical latitudes. One could ask a comparative question: How many LEOS, if stable and placed properly, would it take to cover the earth at Iridium altitudes. The answer comes near something like 16.

Our invention is to remove all orbit rockets, and orbit rocket fuel and also remove all stability rockets and stability rocket fuel. Just let the satellites wander and tumble, and then create the math to create bent pipes and longer routes.

To make StarMesh technology work at similar altitudes we need about 256 satellites. We are inefficient by a factor of about 16. StarMesh is a statistical system. It relies on probabilities to work. Our first patent provided about a 50% chance of working with very complicated ground stations. We need to look up from the ground and see about 12. However, that number provides a potential of 48 satellites visible from a single satellite to make a route that includes satellite to satellite links.

The inventive challenge was to move a 50% chance of working to a number such as 95%. By relying on quickly changing relative creation and destruction of links, we need only wait for a few seconds for a second chance. By the third chance, failure is almost impossible.

The route creation process was challenged by the speed of light. We used some philosophical ideas from Richard Bellman. Several new complicated algorithms were invented. Also many physical features in the satellites are inventive. The concepts are very hard to understand. Routes are created in less than a second. However, it is easy to build, and the guts of each satellite can be held to less than \$3,000. Thus a system could cost about one million dollars.

**Thus, it now costs more to destroy our satellites than it does to replace them. We could start with 300 satellites, and with a loss of 50, the system still works.**

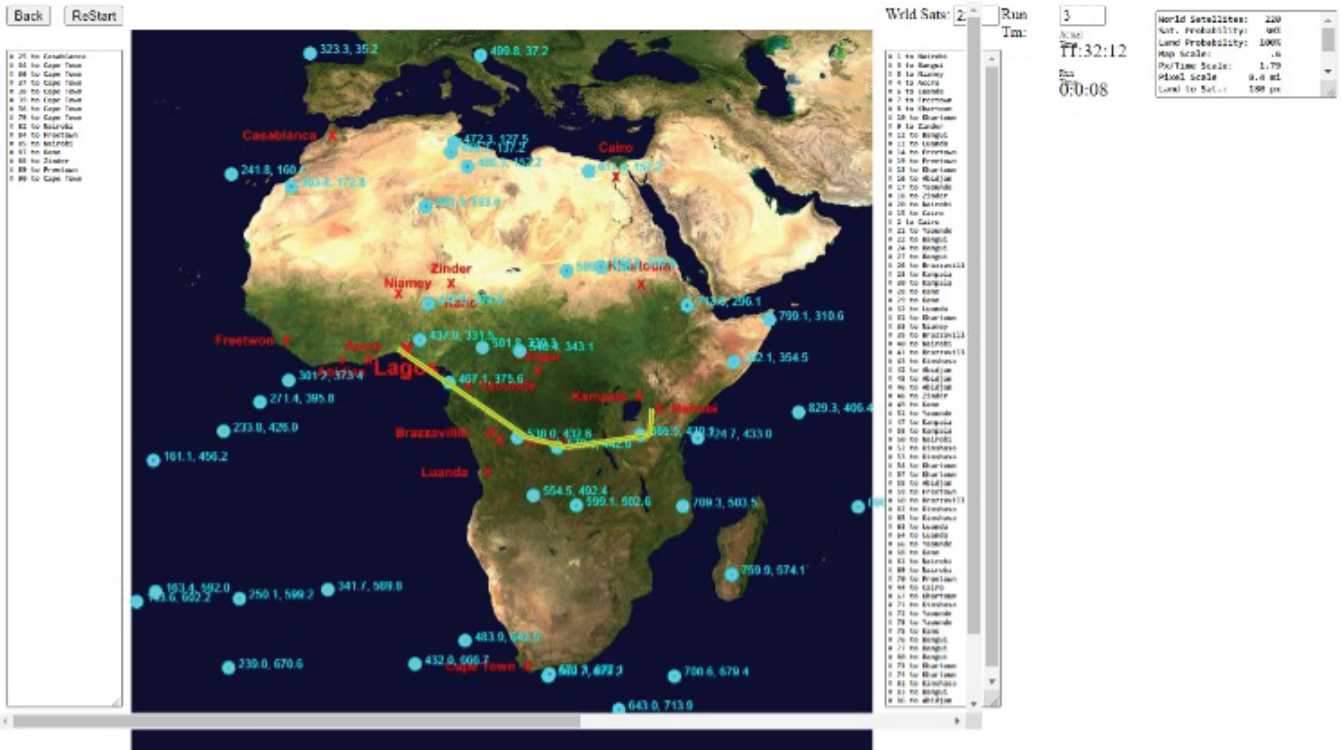
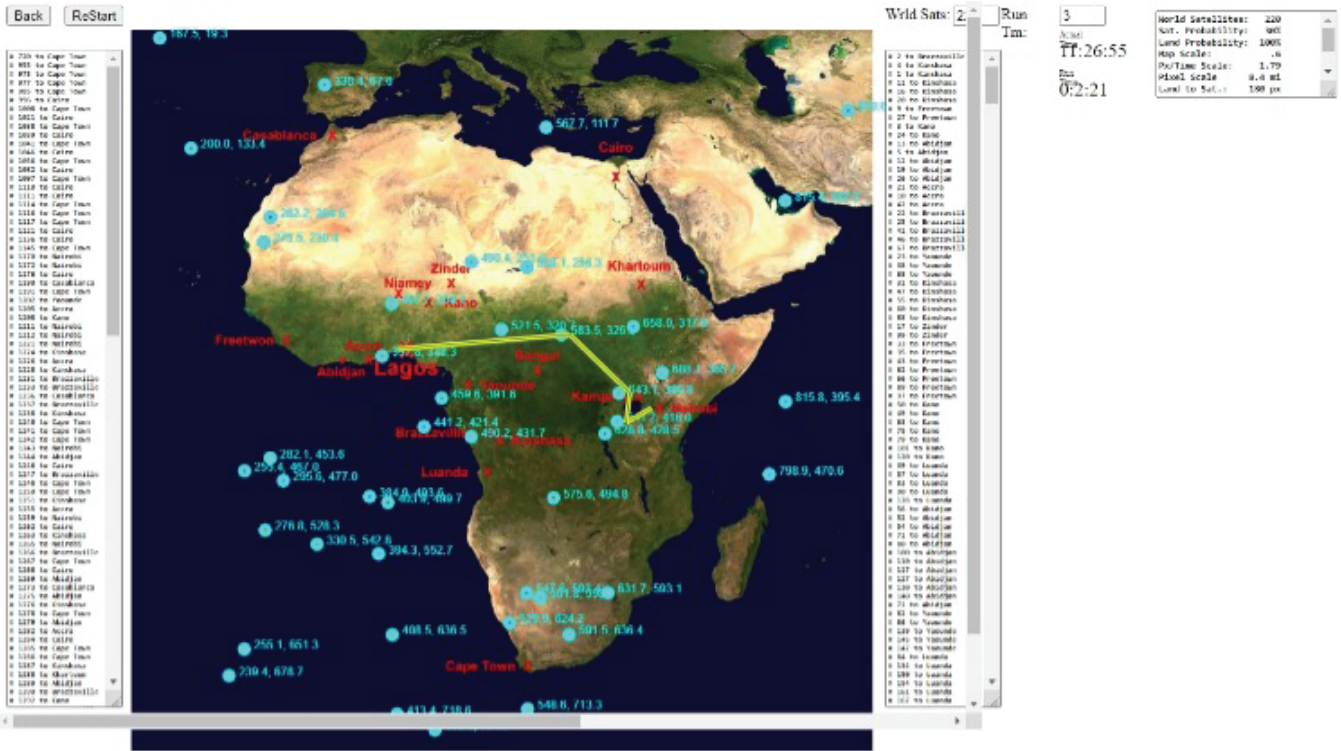

The snapshots above were copied from a web computer simulation showing StarMesh technology at work demonstrating different routes. This simulation only included the traffic coming from and the traffic leaving Lagos, the Capital of Nigeria.

## INFORMAL DISCUSSION

The Starmesh technology given any number of satellites in any location, altitude, or attitude searches for routes between all pairs of ground stations. This is accomplished by a multi-stage decision process where the number of stages chosen limits the number of links in all routes. To limit routes to 6 links, the route creation process would perform 6 steps. Each step can be performed in about 50 milliseconds.

It might be the case for someone to easily understand the algorithms, they must have actually coded a “Dynamic Programming” example.

The decision process can utilize any parameter to be maximized. We prefer the signal to noise ratio across the route. However, maximum signal strength might be more useful.

For a comparison, In the United States at any one time probably around a million vehicles that each are finding their optimum routes to a desired location. This is a two dimensional problem. However, it suggests that millions of packets of data can find their routes. Yes, this is a dynamic satellite map and also a three dimensional problem.

During the multi-stage decision process, the process could also carry along in addition to the best sub-route the second best route. This process has the option of creating a second route and thus using spatial diversity to create a better data system.

StarMesh satellites are small and light weight and have no external appendages. Their windage to mass ratio is less than typical satellites. Thus their life expectancy is higher. Their low cost opens the possibility of using altitudes much lower than 300 miles which would supply greater signal strength. Furthermore, they could be below the useful zone, and ultimately decay further. Thus they can solve part of the space junk problem.

Softbank originally backed the Wyler system, and later let them go bankrupt. This was purchased later by England and India. Softbank planned to use Aerovironment’s bat wing drones. Recently, Softbank asked England for help for long distance routes.

We have created new complex second generation of our drone/satellite routing and system designs that renders many of our first generation concepts obsolete. This has become relevant to the South China Sea and the combination of the Black Sea and Mediterranean Ocean.

## DISTANCE TO HORIZON TABLES

The "Distance to Horizon" concept is very important in radio communication systems. When communication between any two nodes (ground location, aircraft, or even satellites) the need for an open path is important. If the natural curvature of the earth obstructs signal strength, the a radio path is almost certain to not function well, and probably not at all. This constraint leads to the conclusion that high flying balloons and satellites are extremely important for longer communication paths.

Here is a table that shows the distance to horizon for some low flying balloons or drones. This shows the value of making "Lighthouses" on shores to help ships navigate locally. This also shows that when a civilian looks out of a window in a tall building that he can see further than someone on the ground.

### Distance to Horizon – Lower Altitudes

Altitude in Feet	Altitude in Miles	Distance to Horizon
100		12 Miles
500		27 Miles
1,000		39 Miles
2,000		55 Miles
5,280	1	89 Miles
26,400	5	199 Miles
52,800	10	281 Miles

(The altitudes in between would be useful, but below about 200 miles satellite orbits decay quickly. Above about 12 miles, drones may be impossible)

### Distance to Horizon – Higher Altitudes

100	895 Miles
200	1,274 Miles
400	1,825 Miles

Satellites below 100 miles have very short remaining lives. (The results of this table are only estimates. The earth if not perfectly round and ocean smooth, other considerations might apply.)

Is it true for two satellites at 400 miles altitude that they can barely see each other at 3,650 miles?

Is it true a satellite at 400 miles can see a drone at 10 miles for  $(1,825 + 281)$  2106 miles?

Does a satellite at 400 miles with a 1000 foot hill at worst location see  $(1,825 - 39)$  1,786 miles?



# Stochastic Performance Analysis for LEO Inter-Satellite Link Based on Finite-State Markov Chain Modeling

Min Wang, Jinqing Li

School of Computer Science and Technology  
Changchun University of Science and Technology  
Changchun, China

Xiaoqiang Di\*

Changchun University of Science and Technology  
Institute of Space Optical Technology  
Changchun, China  
dixiaoqiang@cust.edu.cn

Yuming Jiang

Norwegian University of Science and Technology  
Department of Telematics  
Trondheim, Norway

International Journal of Digital Information and Wireless Communications (IJDIWC) 8(3): 150-155

The Society of Digital Information and Wireless Communications, 2018 ISSN: 2225-658X (Online); ISSN 2412-6551 (Print)

## Energy-Aware Routing for CubeSat Swarms

Mohamed Atef Ali Madni<sup>1</sup>, *Member, IEEE*, Raad Raad<sup>1</sup>, *Member, IEEE*, Mohamad Raad<sup>2</sup>

<sup>1</sup> School of Electrical, Computer and Telecommunications Engineering, University of Wollongong, NSW, Australia, 2522

<sup>2</sup> Computer and Communication Engineering, Lebanese International University, Beirut, Lebanon

We include the two images above to demonstrate that scientists around the world are studying alternate methods of route creation. These two articles do not relate to our later patent applications at the USA Patent Office. When we file a patent application at the USA Patent Office, and they find nothing related to our patent claims, they allow our application to become a patent. We began this research effort with the goal of a commercial application. Thus, we also have been filing our various patent applications around the world in 10-15 different countries. One interesting fact we have learned is that four different very recent Chinese patent applications each from a different Chinese company were initially examined at the USA Patent Office, and these four applications have to explain their claims with respect to some StarMesh patents.

## WORLD WIDE OPERATION

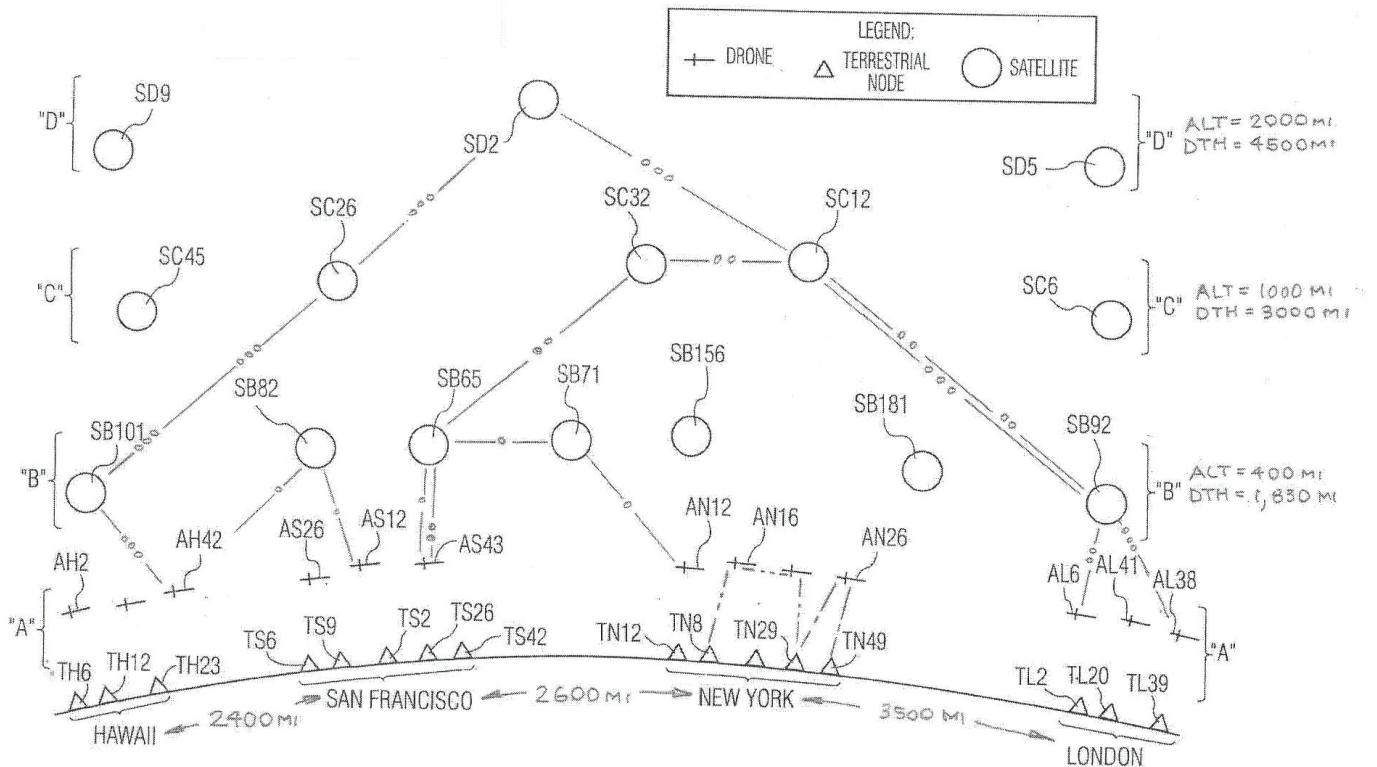

## MODES OF OPERATION

In the diagram above we observe a system that includes several levels of satellites and also many drones (or balloons). Also many ground stations are shown in each Hawaii, San Francisco, New York, and London.

This system is designed to support many local conversations, and simultaneously also support long distance communications. Note a long route from Hawaii to London, and also two local routes in New York.

The satellite routing technology is made feasible by the slow speed of light. This fact permits the short routing messages to be automatically spread in time. In the statistical chance of two routing messages arriving at the same antenna at the same time, the system will just ignore both of them.

However, that speed of light delay luxury is not present in routes between ground stations in the same local area. This problem appears to limit the amount of local traffic that can be supported. Thus special attention to design is required, and a patent pending and future work will provide a solution.

## SUGGESTED EXPERIMENTAL PLAN

### **Task One - CubeSat Experiment**

The first goal is to get some CubeSats into space, and learn and demonstrate the work ability of the chaotic routing software. It has been demonstrated that a mere 2 watts of power in some instances without directional antennas is sufficient power to communicate between CubeSats. The experimental system will have directional antennas, so from a power viewpoint all should be OK.

The higher the altitude chosen will require fewer satellites. It may take some time for them to acquire some dispersal so that they are not in a cluster. Launching them all in an easterly direction will help with potential Doppler problems.

It may be of value to use multi-feed parabolic antennas, but normal parabolic antennas should be sufficient for experiments. Since this is an experiment, we do not need a guarantee of continuous operation and thus about 100 of them should be sufficient. (If in a band between Latitudes)

One required feature is that the system be capable of uploading new and improved software during experimentation. Magnetic Rods optional in this experiment.

### **Task Two - American Football Size and Shaped Satellites.**

This group of satellites to be launched at about 200 miles in altitude. They will not have an unlimited life in space, but this can demonstrate that the weight to drag ratio is high enough that they will have a longer useful life.

These will be a little larger than an American football, and basically of that shape. The magnetic rods will be included to hold them approximately horizontal. Perhaps about 18 total antennas will be distributed along the sides and bottom of each satellite. Perhaps some multi-feed antennas could be included.

Even Though there were multiple shorter routes, the computer logic selected an optimum route based on signal to noise. Note the first link from Port Harcourt actually went in the wrong direction. Furthermore, Port Harcourt might have had to wait a second or two to achieve this high quality route.

○ Radio Node: Satellite-Drone-Balloon

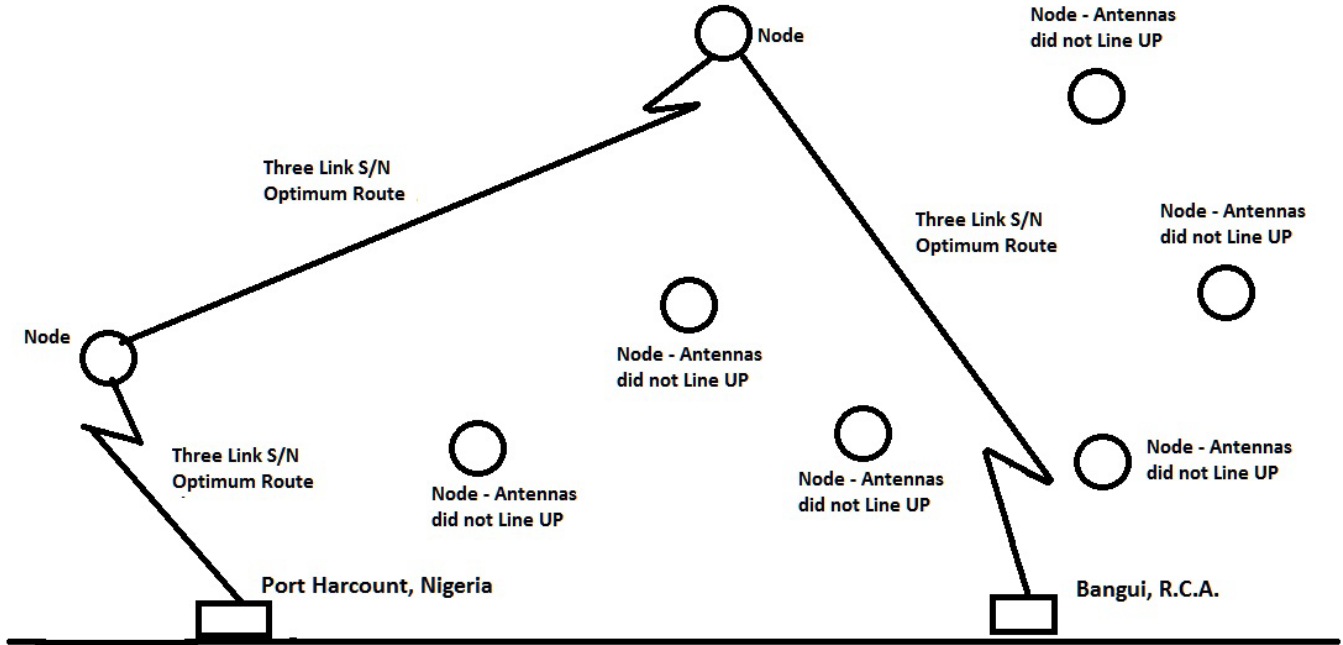

This page and the following pages are optional reading. Their goal is to explain some of the complex issues involving a satellite communication system, and their relationship to the new StarMesh technology. One must remember that StarMesh is a system based on probabilities. If a route was not available, a new opportunity will arise in the next cycle. Each cycle is in two parts. The first part is route creation, and the second part is data transmission.

This figure displays a route from Part Harcourt in Nigeria to Bangui a city in central Africa. Usually, the StarMesh system finds a route like this almost immediately, but occasionally, a route might not be available based on statistics, and the message might have to wait for another cycle. In a system of uncontrolled satellites relative positions change rapidly, and overall wait times for an independent second chance or third chance can be very short.

The altitude of the satellites or drones will dictate cycle length. High orbit satellites will face longer distance between them, and thus the speed of light must be considered.

A few seconds later, the nodes have not moved much. However, the relative positions of their antennas has changed. This could be from random motions, or intentional movements caused by a flying drone. Or this might be caused by a balloon being moved by wind.

○ Radio Node: Satellite-Drone-Balloon

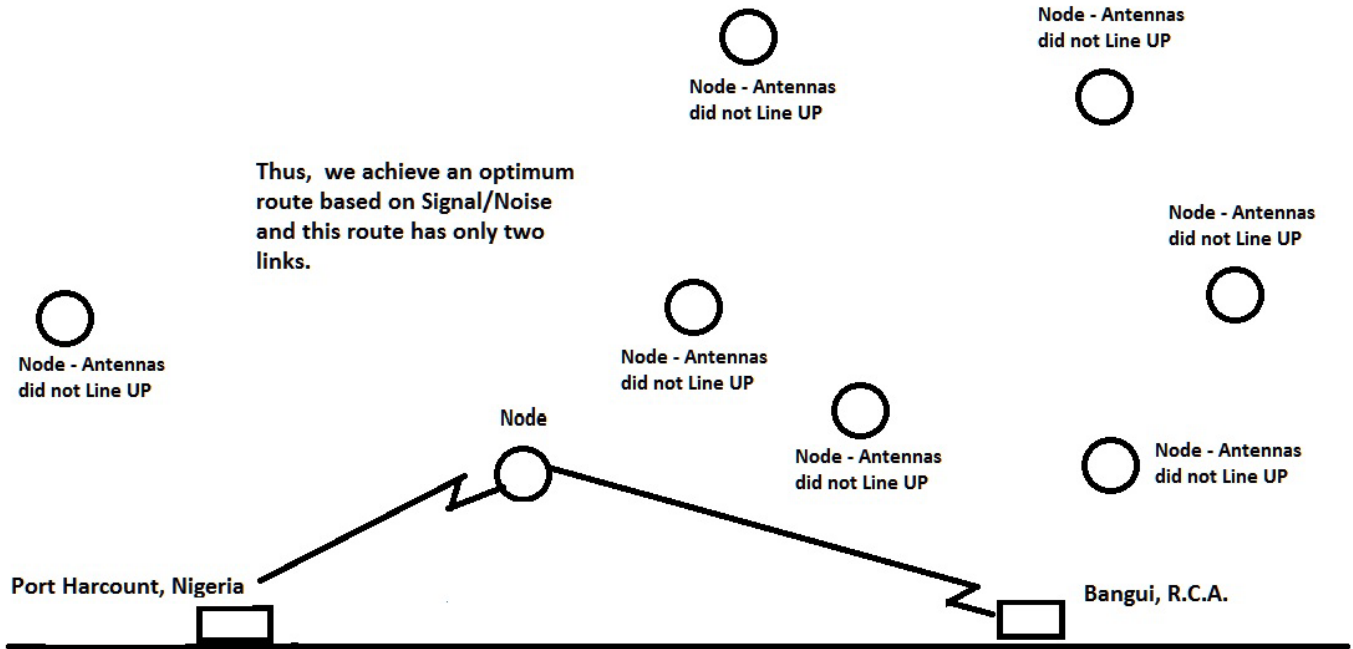

The figure above shows what might happen in a subsequent cycle to the previous cycle as displayed on the previous page. Note an entirely different route from Port Harcourt to Bangui is created.

For satellites at altitudes about 350 to 400 miles, the following discussion can be used for cycle length. The route creation cycle is divided into many steps. Furthermore, we need to explain how many links it will take to go half way around the world. If the circumference of earth is about 25,000 miles, and thus maximum distance half way around the planet is about 12,500 miles. The distance between two satellites that can see each other is up to 3,600 miles, we can note that 4 or more links might be required.

Each step in the route creation cycle needs to take about 40 milliseconds. This time is needed, as routing messages need to have time to make long distance connections subject to the speed of light. Thus, if we safely assume 50 milliseconds per step, and 6 or 7 steps, we find that the total time required to create routes is less than one half second. Then, in a system of very short messages that can be sent in one half second, we note that a total cycle time could be about one second in total.

### Antenna Pairing

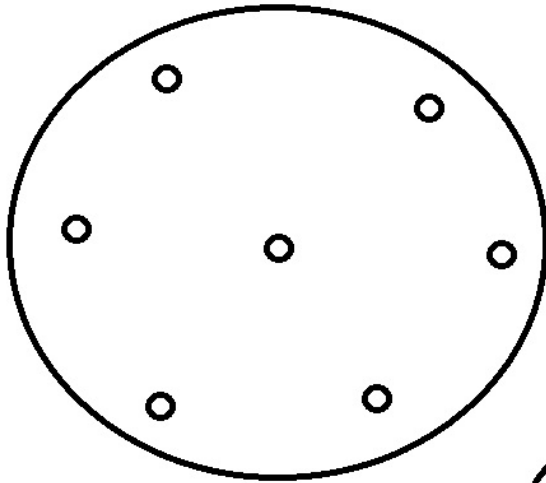

Front View of parabolic antenna with 6 directions plus one in the center.

It has been reported that CubeSats with two watts of power and a single omni antenna can communicate with each other.

StarMesh technology observes that with paired parabolic antennas, the received signal can be increased.

Furthermore, parabolic antennas can be designed with multiple feeds to improve signal quality.

These antenna changes can add greatly to received signal to noise ratios which increases data rates.

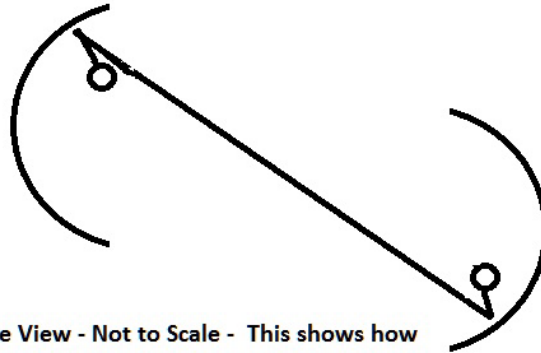

Side View - Not to Scale - This shows how feed matching can improve signal strength.

In the StarMesh satellite and drone technology, probability plays a key role. If antennas accidentally line up, then a link is possible. Radio engineers understand in any radio system antennas that focus on either an incoming signal or a transmitted signal can greatly increase received signal strength.

StarMesh technology automatically detects optimum antenna choice for antenna pairing. Furthermore, multi-feed antennas can be automatically paired to the optimum feed on each antenna.

To hold wind resistance to a minimum thus increasing either drone or satellite lifetimes, it is desired to place the antennas below the surface of an antenna or drone, thus permitting less air flow resistance.

The probabilities for a useful link can be increased greatly by an intentional spinning of a satellite. With a 30 degree antenna, the chances of being useful is quite small. However, by adding multiple antennas, the probabilities can be increased. Also true for a balloon

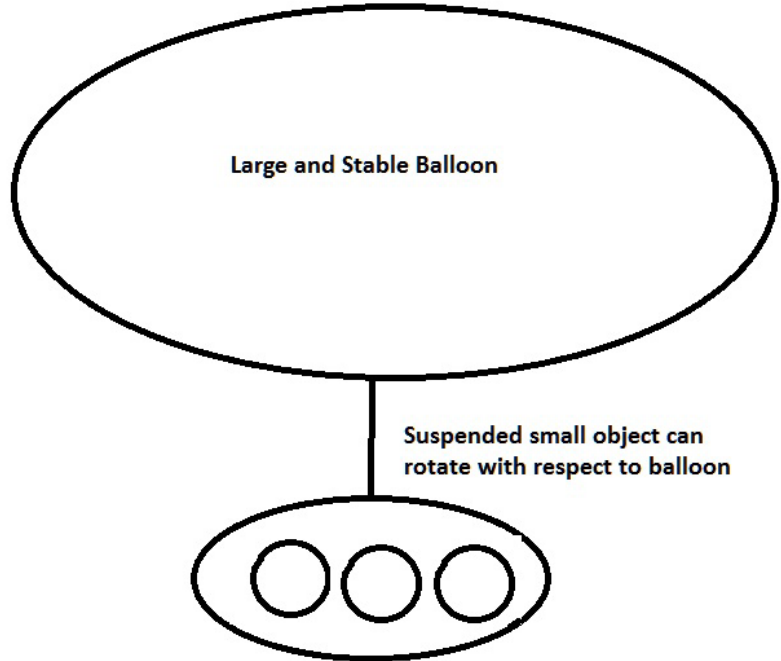
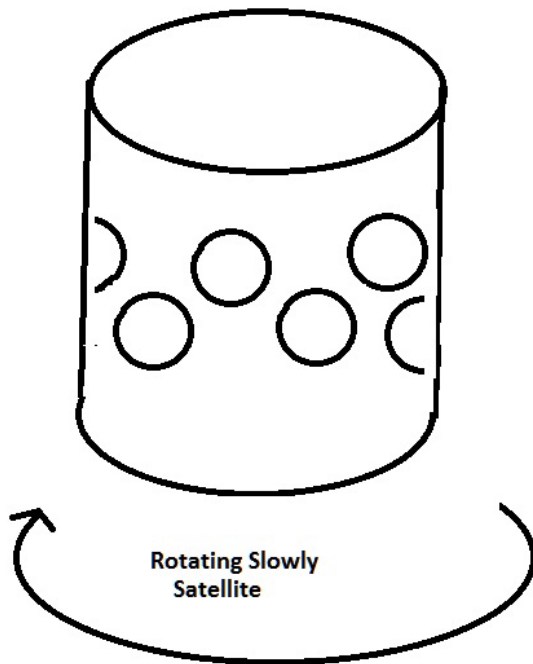

In StarMesh technology, satellites are allowed to wander and tumble in any free form manner that statistically can occur. Thus the routing methodology is powerful enough to tackle any statistical formation. The routing technology can take advantage of random locations in three dimensions, and also random orientations.

However, it would seem obvious that if satellites were held approximately horizontal, that costs could be reduced and that statistics could be improved. Solar Panels would be placed primarily at the top of the satellite, and antennas would be pointed down or approximately sideways in anticipation of the most probable probable links.

Thus in the figures above show a satellite and a balloon that are held approximately horizontal.

To improve the statistical operation of the system, intentional rotation does wonders for the probabilities of a link between two devices. However, this requires careful design, as the link might disappear during data transmission. In a system design with 1/2 second for route creation and 1/2 second for data transmission, cycles occur in one second. Thus multiple cycles can occur in just a few seconds. Thus, the spinning concept can guarantee in a statistical sense always finding a route in a few seconds.

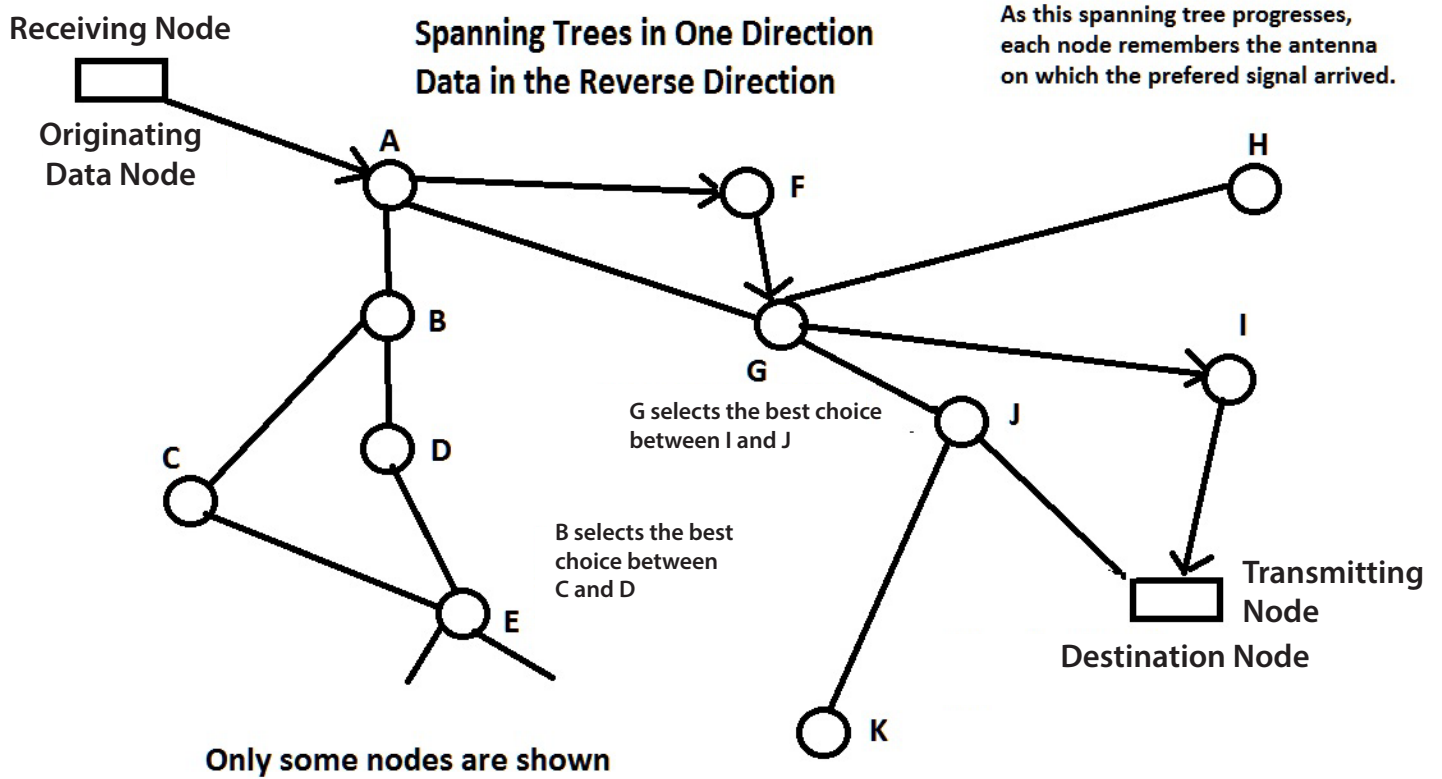

**Each node now knows how to send data to the transmitting node.**

We have indicated with arrows which is the optimum path based on signal measurements

The basic concept of distributed intelligence creating routes is shown above. The optimum route is displayed by showing links ending with a pointed arrow.

The routing messages flow step by step from Transmitting ground stations to Receiving ground stations. Then in a reverse direction the actual data Originating ground station (previously called the receiving ground station) sends the actual data step by step to a Destination ground station (previously called the transmitting ground station.)

In a system of about 100 ground stations this process is happening simultaneously between all of them, and thus the system creates 100 X 100 equal 10,000 routes all at the same time. Multiple routing messages to be transmitted from nodes are placed into chains.



## Distance to Horizon - Frequency Reuse

Abreviated Table - Conceptual-Miles

Altitude	Distance to Horizon
100 Miles	895 Miles
200 Miles	1,281 Miles
400 Miles	1,825 Miles

StarMesh and most other satellite systems face a limitation of radio spectrum. Furthermore, StarMesh faces a problem of bandwidth for routing messages

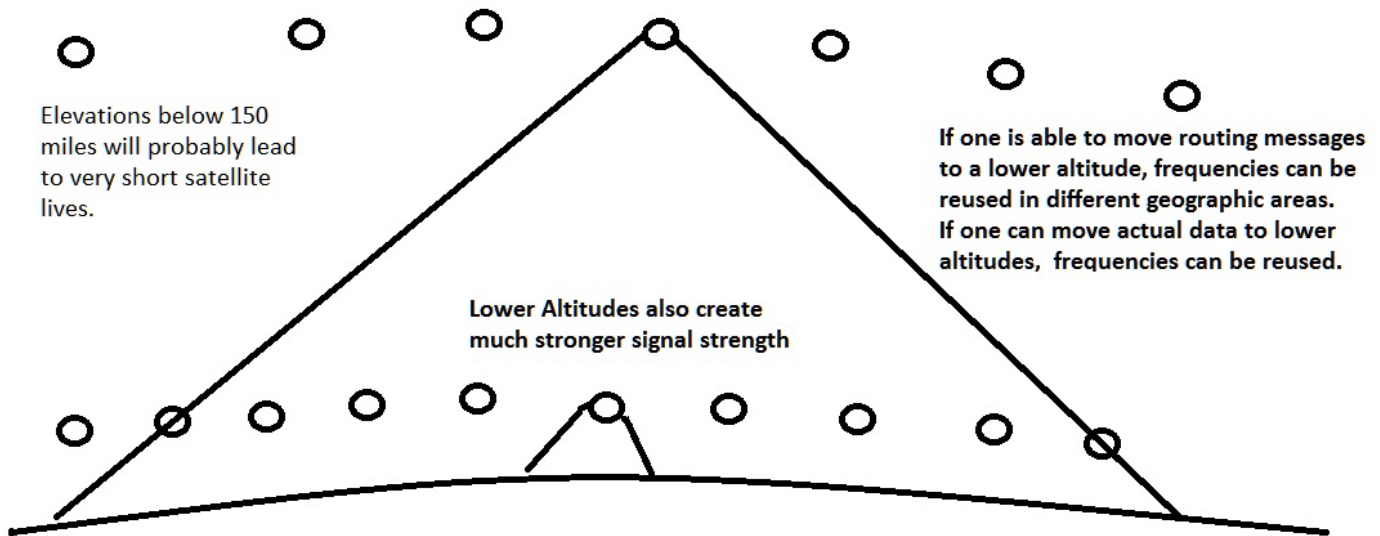

In most multi-user radios systems including cellular radio, the demand for system capacity leads to enormous demands for government allocated frequency bands. In the earlier cellular radio concepts, base station towers were held to 50 foot elevation to permit cell like patterns to be repeated multiple times in a major metropolitan areas.

Furthermore in cellular radio the base stations transmitted in one band, the the base stations listened in a second band. These bands were reversed in the hand held phones. This can be referred to as the R/T and T/R solution. This solution permits each end of the conversation to simultaneously talk and listen.

Frequency reuse in a satellite system is also important. This interesting concept can also be used in random orbit systems. The concept is to have two layers of satellites that can make links with each other. The higher elevation one is T/R and the lower elevation one could be R/T. This design permits the lower level to connect to the ground, and provide good signal strength. However, this permits the use of the higher level to spread system coverage over a wider area. In fact, the higher one could have two different bands for upper level satellite to satellite links.

## Add Drones and Balloons to System

**The addition of drones/balloons can increase frequency reuse, and also increase signal strength. Furthermore, the lower altitudes of near 10 miles still provide widespread coverage**

Figure 22 in StarMesh patent 10,979,136 shows balloons and drones adapted into a satellite system.

Table of Distance to Horizon

Altitude (Miles)	Distance to Horizon (Miles)
5 Miles	199 Miles
10 Miles	281 Miles

SoftBank, a giant Japanese Venture Capital Company, has created a concept called "Smart Africa". Their business concept takes advantage of the large distance to horizon from 10 miles. That means a single drone can cover an area with a radius of 281 miles.

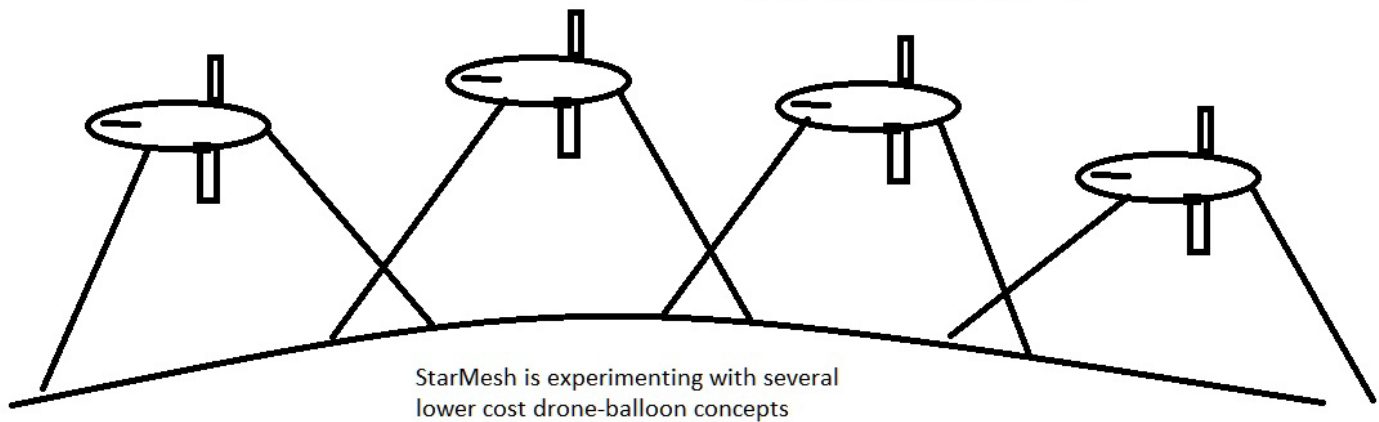

Although we covered drones and balloons as part of our system in 10,979,136, drones and balloons can route among themselves using our free form routing technology.

One advantage that is explained in one of our pending patents is the relationship of nodes to the T/R and R/T situation. Furthermore, our technology can support drones and balloons at different altitudes.

2022-06-15- SmartG-  
LagosToZanzibar

### Incorporate Satellites into a Drone System

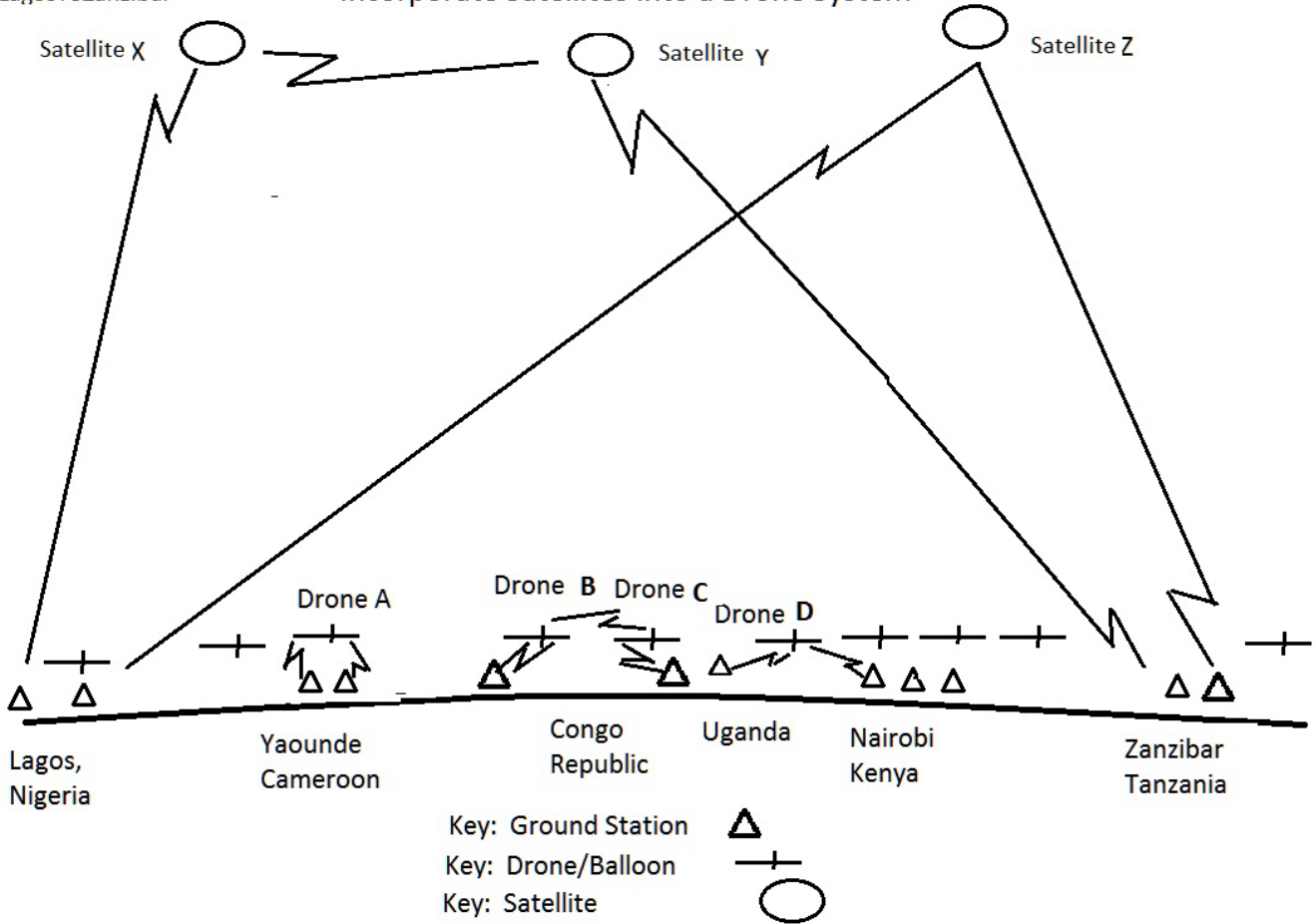

As one contemplates any communication satellite technology, one realizes several important concepts.

- 1) Signal Strength from LEO satellites at elevations over 300 miles in altitude is weak. Better antennas can improve this, but signals will still be weak.
- 2) Signal strength from drones and balloons at about 10 miles in altitude can penetrate through car tops and building roofs.
- 3) By creating multiple local areas for drone usage, drone frequencies can be reused.
- 4) By connecting drones in multiple areas to satellites communication between distant areas can be aided by satellites.
- 5) Although we show here a Pan-African system, the diagram in our pending patent shows Hawaii, California, New York, and London. The concept is the same.

### Drone concepts versus Dirigible Concepts

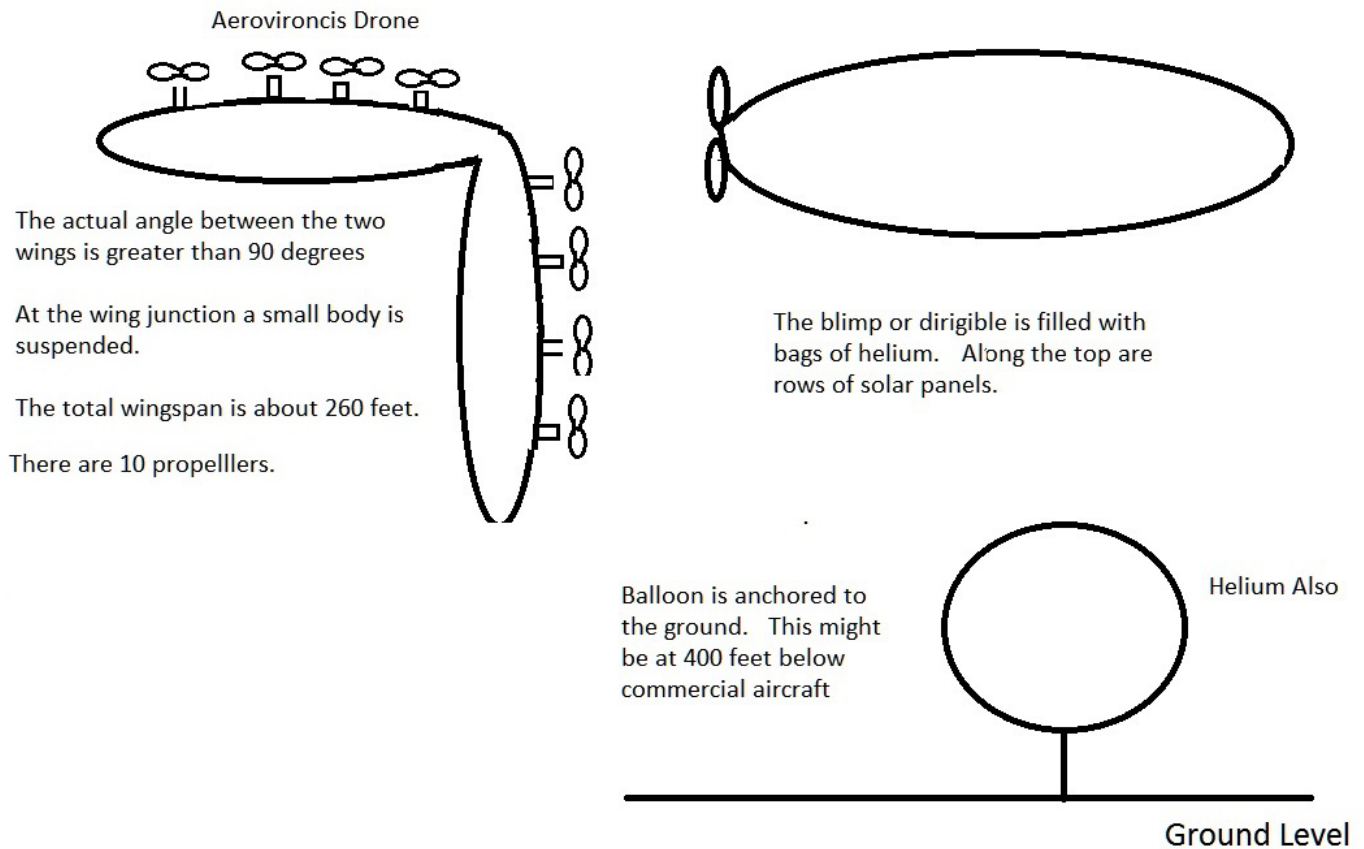

Aerovironics has designed a wonderful drone. It is shaped something like a bat wing, and is powered by multiple propellers. By using Solar Panels to power the propellers, they have created a drone that can stay aloft almost permanently.

This drone will be expensive, and will be easy to find and destroy.

StarMesh has been working on multiple different drone/balloon designs that can be incorporated easily into the StarMesh routing protocols.

One concept shown above is a dirigible like device filled with helium. The solar panels provide power to a propeller that can help hold this device over a general area. In strong winds, this might just blow away, but if low enough in cost it can be replaced.

The second device is a balloon held in approximate position by an anchor to the ground. This can easily be held in position.

The first device can operate above 10 miles to be above commercial aircraft. The second device can operate at 400 or less feet, and operate below commercial aircraft. Either device can operate at intermediate altitudes in times of emergency need.

## Space, Frequency, and Technology Diversity

Sending a data packet twice can improve the reliability of the StarMesh system. Below we show an example of sending a message via space diversity.

However, frequency diversity is also supported. Finally, our radio mesh can be included in other systems by having selected nodes being able to utilize more than one technology.

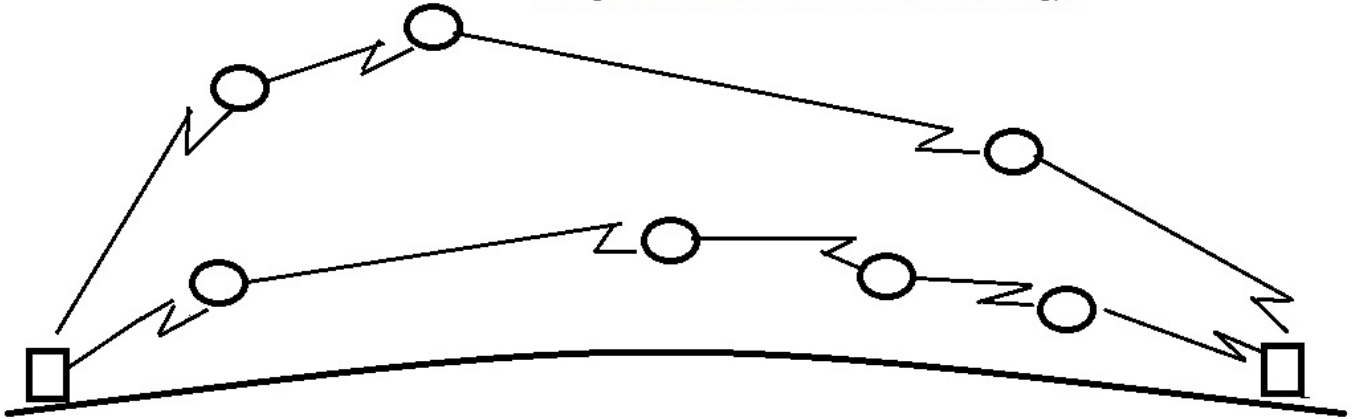

One of the features of the StarMesh routing technology is that it lends itself to using diversity to achieve higher data rates with better accuracy.

The simplest diversity to understand is spatial diversity. In the route creation logic, one can carry along the second best sub-route, and as the routing evolves this will automatically guarantee a second best spatial diversity choice.

Frequency diversity is also straightforward. When the routing method finishes with the optimum route, the data can be sent twice, once on each set of frequencies. By separating the frequency bands used, different frequencies would be subject to different interference from natural and man made causes.

Technological diversity will require that some nodes have two different technologies. The bi-diversity nodes can be used to connect two different systems, and they can also be used in the same system as a means to help insure accurate data transmission

### Lower Altitude Low Earth Satellites

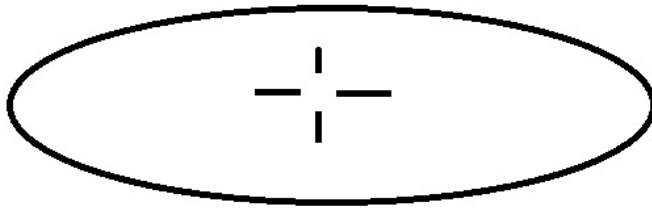

Top View Showing Magnetic Rods

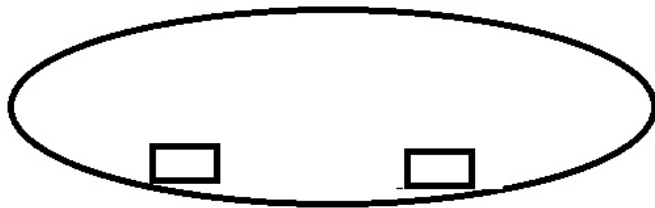

Side View Showing Batteries

There appears to be an altitude zone where LEO satellites can not operate very well. When LEOs are below 100 miles in altitude, the air drag becomes serious and they are quickly led into a death spiral that leads to their destruction.

Above 350 miles they can be in stable orbits, but signal strength issues back to earth become problematical.

By housing the solar panels, electronics, and antennas inside the satellite shell, the windage can be reduced compared to other current designs. Thus, the weight to drag ratio can be adjusted, and a much longer satellite life can be achieved. Because of the low cost of each satellite, we are hopeful that they can be launched at altitudes below 200 miles.

**THUS MUCH BETTER SIGNAL STRENGTH**

Also solves space junk issues

By placing the batteries and heavier electronics at a lower position in the satellite, the satellite can be held in an almost horizontal position. By the selection of one of four magnetic rods receiving current, the satellite can be pointed in any of the four directions. However, by putting current into two of them and carefully controlling the ratio of currents between them any desired pointing direction can be achieved.

This table of approximate cube sat lifetimes has been compiled using several different technical articles. These should not be considered accurate, but still very useful for understanding orbit decay issues. The diagram above indicates how magnetic rods can point a satellite for minimum drag, and the battery location can help keep a satellite horizontal.

200 kilometers	120 miles	About one day
300 Kilometers	180 miles	About 30 days
400 Kilometers	240 Miles	About one year
500 Kilometers	300 Miles	About 10 years (7 years) and 3 years)

From this we might conclude that in emergency situations, satellites at 200 miles would certainly be useful. In fact in some emergencies satellite with good weight to windage ratios might be useful as low as 180 to 190 miles in altitude. Furthermore, there is a lot of research for methods of creating thrust in small and tiny satellites.

## STRATEGIC OVERVIEW

This project began as a commercial/consumer satellite project. Based on the assumption that many companies would only receive limited bandwidth allocations from governments, we were careful to design a system that could operate in a limited bandwidth.

Our first awarded patent for this project evolved around a bent pipe design. The basic goal was to lower cost by orders of magnitude. By removing rockets and rocket fuel for both altitude and attitude (pitch roll, and yaw) we could reach the goal. However, we attempted to use a sphere with both solar panels and antennas on every surface. With reasonable assumptions for antenna beam widths that were limited by space needed for solar panels, and combined with a hemispheric ground station with many high gain antennas, the system would only work about half the time. Clearly, if this system were to be useful, it needed inventive improvement.

The twin concepts of antenna pairing, and multi-feed antennas would allow high data rates, and these improvements were a step in the right direction.

The concept of rotating the random orbit satellites about randomly pointing axis, certainly could be use to improve the probabilities.

The two above applications led us to begin filing International patents, and we began with about 25 countries. Since then we have reduced it to about 12 countries and organizations.

Our fourth patent attempted a world wide system, and included some new ideas, but appeared to be limited in operation.

Our fifth and final patent created a Bellman like routing system with distributed intelligence. We had arrived at the point, where giant companies such as Chevron, Walmart, and Rio Tinto could have their own private red phone satellite systems. Furthermore, governments could have their own private satellite systems. All these systems would be at very low costs, and thus be easy to keep operational even if adverse environments were to exist. We felt in summer of 2020 that we were done!

However, we began to wonder about capacity of these systems. We quickly realized that numerous additional inventions were needed to improve both the probabilities of route selection, the number of terrestrial nodes supported, and the amount of data to be transmitted.

Thus we began work on a series of additional patent applications, including International, and provisional/formal applications in the US.

Then with the Ukraine situation, we discovered that our technology could survive a direct attack, and thus it should be very useful and valuable.

STARMESH GLOBAL™ WORLDWIDE PATENT PORTFOLIO

PATENT No./APPL. No.	COUNTRY	PAT. ISSUE DATE/ APPL. FILING DATE	PRIORITY DATE	STATUS
----------------------	---------	---------------------------------------	---------------	--------

**FAMILY A: RADIO SYSTEM USING SATELLITES  
("BENT PIPE")**

Pat. No. 10,084,536	United States	9/25/18	8/25/16	In force - expires 7/21/37
Pat. No. 10,998,962	United States	5/4/21	8/25/16	In force - expires 7/21/37
App. No. 17/214,821	United States	3/27/21	8/25/16	Pending (Pub. No. US 2021/0344412)

**FAMILY B: RADIO SYSTEM USING NODES  
("ROTATING SATELLITES")**

Pat. No. 10,447,381	United States	10/15/19	8/25/16	In force - expires 8/23/37
Pat. No. 11,038,586	United States	6/15/21	8/25/16	In force - expires 8/23/37
App. No. 17/317,310	United States	3/27/21	8/25/16	Pending (Pub. No. US 2021/0399793)

**Foreign Patents & Applications**

Pat. No. ZL 2017800519208	China	11/24/20	8/25/16	In force - expires 8/23/37
Pat. No. ZL 2020112170244	China	7/21/22	8/25/16	In force - expires 8/23/37
Pat. No. HK40006930	Hong Kong	8/20/21	8/25/16	In force - expires 8/23/37
Pat. No. EP3504808	European PO	7/27/22	8/25/16	In force - expires 8/23/37
App. No. 201927009397	India	3/11/19	8/25/16	Pending
Pat. No. 264883	Israel	5/28/20	8/25/16	In force - expires 8/23/37
App. No. 2019-507247	Japan	2/5/19	8/25/16	Pending
Pat. No. 370247	Mexico	12/5/19	8/25/16	In force - expires 8/23/37
Pat. No. RP:NG/PT/2018/2945	Nigeria	11/19/18	8/25/16	In force - expires 8/23/37
App. No. 1-2019-550023	Philippines	2/8/19	8/25/16	Pending
App. No. 10202102036V	Singapore	2/27/21	8/25/16	Pending
Pat. No. 2019/00468	South Africa	9/25/19	8/25/16	In force - expires 8/23/37

**FAMILY C: RADIO SYSTEM USING NODES WITH HIGH GAIN ANTENNAS  
("STAR ANTENNA")**

Pat. No. 10,085,200	United States	9/25/18	9/29/17	In force - expires 9/29/37
Pat. No. 10,791,493	United States	9/29/20	9/29/17	In force - expires 9/29/37
Pat. No. 11,356,921	United States	6/7/22	9/29/17	In force - expires 9/29/37
App. No. 17/752,912	United States	5/25/22	9/29/17	Pending

**Foreign Applications**

App. No. 2018341561	Australia	4/15/20	9/29/17	Pending
App. No. 3076010	Canada	3/16/20	9/29/17	Pending
Pat. No. ZL 2018800627936	China	6/17/22	9/29/17	In force - expires 9/27/38
App. No. ZL 2022106613390	China	6/13/22	9/29/17	Pending
App. No. 62020022409.0	Hong Kong	12/8/20	9/29/17	Pending
App. No. 18 860 787.3-1215	European PO	4/3/20	9/29/17	Pending
App. No. 202027017798	India	4/26/20	9/29/17	Pending
App. No. 2020-516855	Japan	3/23/20	9/29/17	Pending
App. No. 10-2020-7012073	South Korea	4/24/20	9/29/17	Pending
App. No. MX/a/2020/003736	Mexico	4/16/20	9/29/17	Pending
App. No. NG/PT/C/2020/4428	Nigeria	3/20/20	9/29/17	Pending
App. No. 1-2020-550083	Philippines	3/13/20	9/29/17	Pending
App. No. 11202002249R	Singapore	3/11/20	9/29/17	Pending

**FAMILY D: DATA TRANSMISSION SYSTEMS AND METHODS USING SATELLITE-TO-SATELLITE RADIO LINKS  
("ROUTES BY ORBITAL KNOWLEDGE")**

Pat. No. 10,291,316	United States	5/14/19	12/11/17	In force - expires 7/13/38
Pat. No. 10,784,953	United States	9/22/20	12/11/17	In force - expires 7/13/38
Pat. No. 11,206,079	United States	12/21/21	12/11/17	In force - expires 7/13/38
App. No. 17/540,470	United States	12/2/21	12/11/17	Pending (Pub. No. US 2021/0231758)

**Foreign Applications**

App. No. 3083425	Canada	12/5/20	12/11/17	Pending
App. No. 2018800854658	China	7/3/20	12/11/17	Pending



PATENT NO./APPL. NO.	COUNTRY	PAT. ISSUE DATE/ APPL. FILING DATE	PRIORITY DATE	STATUS
App. No. 62021024812.1	Hong Kong	2/3/21	12/11/17	Pending
App. No. NC2020/0008363	Colombia	7/7/20	12/11/17	Pending
App. No. 18 888 292.2-1205	European PO	12/5/20	12/11/17	Pending
App. No. 202027029277	India	7/9/20	12/11/17	Pending
App. No. 2020-529759	Japan	6/1/20	12/11/17	Pending
App. No. 10-2020-7019847	South Korea	7/9/20	12/11/17	Pending
App. No. MX/a/2020/005990	Mexico	6/8/20	12/11/17	Pending
App. No. NG/PT/C/2020/4632	Nigeria	6/10/20	12/11/17	Pending
App. No. 1-2020-550668	Philippines	5/20/20	12/11/17	Pending
App. No. 11202004637S	Singapore	5/19/20	12/11/17	Pending

**FAMILY E: COMMUNICATIONS SYSTEMS AND METHODS WITH STOCHASTICALLY DISTRIBUTED ORBITING SATELLITES (“ROUTING ALGORITHMS FOR SATELLITE COMMUNICATIONS”)**

Pat. No. 10,979,136	United States	4/13/21	7/12/18	In force – expires 7/11/39
App. No. 17/203,789	United States	3/17/21	7/12/18	Pending (Pub. No. US 2021/0344409)
<b>Foreign Applications</b>				
App. No. 2019301682	Australia	12/22/20	7/12/18	Pending
App. No. 3104677	Canada	12/21/20	7/12/18	Pending
App. No. 2019800553138	China	2/22/21	7/12/18	Pending
App. No. 19 834 930.0-1205	European PO	2/12/21	7/12/18	Pending
App. No. 62021042678.4	Hong Kong	11/18/21	7/12/18	Pending
App. No. 202027029277	India	2/11/21	7/12/18	Pending
App. No. 279844	Israel	12/29/20	7/12/18	Pending
App. No. 2020-529759	Japan	1/4/21	7/12/18	Pending
App. No. 10-2021-7004339	South Korea	2/11/21	7/12/18	Pending
App. No. MX/a/2021/000301	Mexico	1/11/21	7/12/18	Pending
App. No. NG/PT/C/2021/5140	Nigeria	1/1/21	7/12/18	Pending
App. No. 1-2021-550110	Philippines	1/12/21	7/12/18	Pending
App. No. 11202012897W	Singapore	12/22/20	7/12/18	Pending
App. No. 2021/00600	South Africa	1/27/21	7/12/18	Pending
App. No. 1-2021-00751	Vietnam	2/9/21	7/12/18	Pending

**FAMILY F: DATA TRANSMISSION SYSTEMS AND METHODS FOR LOW EARTH ORBIT SATELLITE COMMUNICATIONS (“DATA TRANSMISSION DIVERSITY”)**

App. No. 17/322,950	United States	5/18/21	5/18/20	Pending (Pub. No. US 2021/0359751)
---------------------	---------------	---------	---------	------------------------------------

**FAMILY G: DATA TRANSMISSION SYSTEMS AND METHODS FOR LOW AND VERY LOW EARTH ORBIT SATELLITES (“AERODYNAMIC LEO AND VLEO SATELLITES”)**

App. No. 17/367,663	United States	7/6/21	7/10/20	Pending (Pub. No. US 2022/0029699)
<b>Foreign Applications</b>				
App. No. PCT/US2021/40408	PCT	7/6/21	7/10/20	Pending (Pub. No. WO 2022/010819)

**FAMILY H: SATELLITE MESH SYSTEMS AND METHODS FOR CREATING RADIO ROUTES BETWEEN MOVING USERS (“CONNECTING MOVING USERS VIA SATELLITES”)**

App. No. 17/539,236	United States	12/1/21	12/2/20	Pending (Pub. No. US 2022/0173795)
---------------------	---------------	---------	---------	------------------------------------

**FAMILY I: SYSTEMS AND METHODS FOR CREATING RADIO ROUTES AND TRANSMITTING DATA VIA ORBITING AND NON-ORBITING NODES (“WORLDWIDE COMMUNICATIONS USING DRONES AND SATELLITES”)**

App. No. 17/539,240	United States	12/1/21	12/2/20	Pending (Pub. No. US 2022/0173796)
---------------------	---------------	---------	---------	------------------------------------

# Moving a Ball to a New Place - Moving a Data Packet to a New Place

Playing Catch and Basketball Free Throw

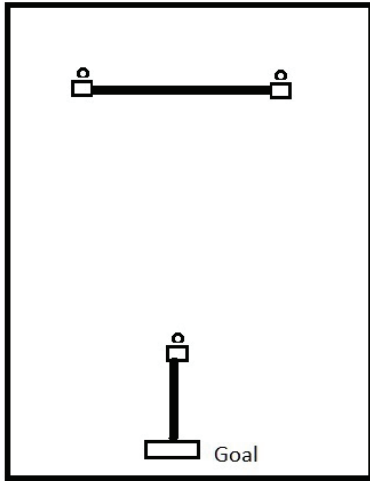

Today's Iridium Satellite Strategy  
Flat Projection of Routes on Spherical Earth

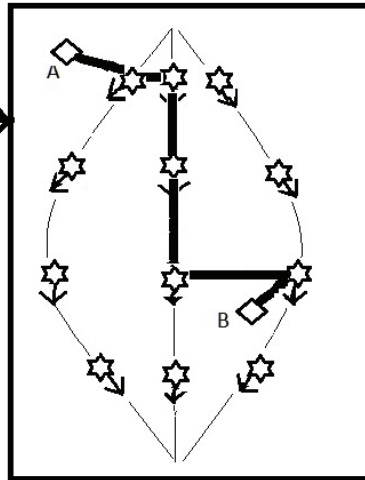

## Heavy Giant Satellites

Satellites and Motion Direction

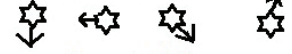

Terrestrial User



Satellites Retain Relative Positions

Route Description

User A to Satellite  
 Satellite - One Hop East  
 Satellite - One Hop South  
 Satellite - One Hop East  
 Satellite to User B

Similar Concepts

Players in Fixed Positions



Basketball

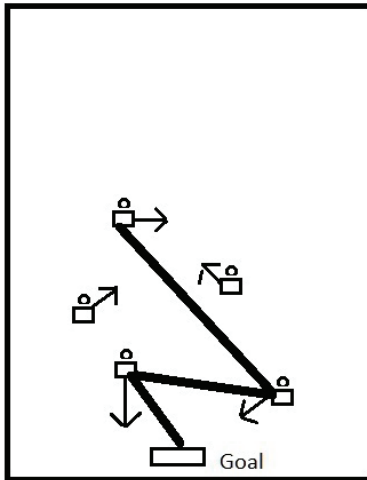

StarMesh Satellite System  
Flat Projection of Routes on Spherical Earth

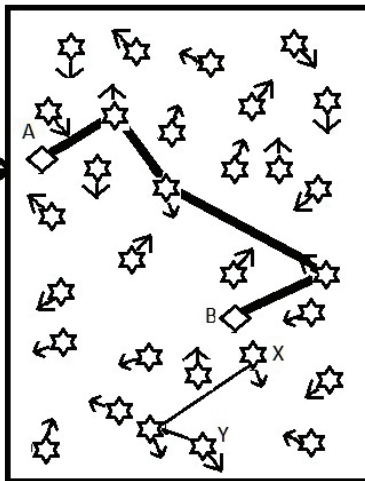

## Small Low Cost Pico Satellites

Many more randomly located satellites of very low cost. They wander and tumble without control.

Routes A to B and X to Y

This is controlled without any strategy and without any central computer.

StarMesh technology creates the most optimum quality route

Width of black lines are proportional to bandwidth

Images and video take more bandwidth than voice

Players move at different speeds in different directions

Similar Concepts

The coach watches from the side, and the players self organize in real time to change positions and create a route that can lead to a basket

# If a Route is Available, StarMesh Technology Will Find It

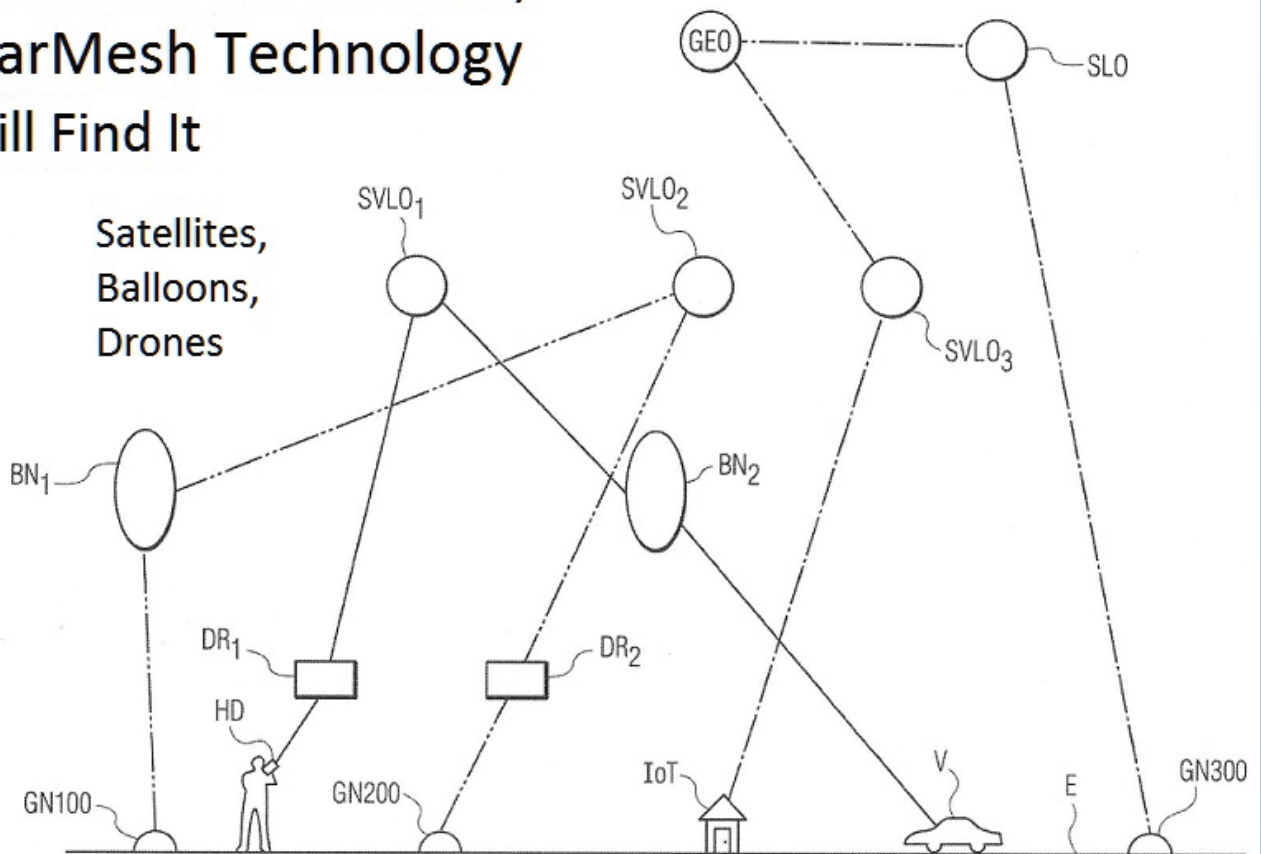

FIG. 22

Copied From: 10, 979,136